

Magnetic Assisted Ball Burnishing of Magnetizable and Non-Magnetizable Materials

Zsolt Ferenc Kovács^{1,3}, Zsolt János Viharos^{2,1}, János Kodácsy¹, Roland Sándor¹

¹John von Neumann University, GAMF Faculty of Engineering and Computer Science, Dep. of Vehicle Technology & Faculty of Economics and Business, Department of Economics and Law, Kecskemét H-6000 Hungary, kovacs.zsolt@gamf.uni-neumann.hu

²Centre of Excellence in Production Informatics and Control, Institute for Computer Science and Control of the Hungarian Academy of Sciences (MTA SZTAKI), H-1111, Kende str. 13-17., Budapest, Hungary

³Department of Manufacturing Science and Technology, Budapest University of Technology and Economics, Budapest H-1111 Hungary

Abstract – The goal of the reported research was to evaluate the machining conditions the magnetizable and non-magnetizable materials by the novel permanent magnetic ball burnishing tool. C45 steel, KO36 austenite steel, AA7075 aluminium and PA6 polymer materials were applied in the experiments. The main aim was to determine the optimal magnetic assisted ball burnishing technological parameters for these materials taking in consideration the hardness and roughness of the surface, too. Taguchi design of experiment methodology was applied in this study to simply look for optimal technology, compared to other kinds of technologies reported in various scientific papers. Surface quality is a complex feature that refers to the micro-geometrical characteristics of the machined surface. It includes roughness and waviness and gives a realistic picture about the top of the surface, while micro hardness and grains structure are especially important on sub-surface level. The results mirrored that all of the tested materials can be burnished by the novel Magnetic Assisted Ball Burnishing (MABB) tool, however, the results from the economical viewpoints are diverse. The novel MABB tool was mainly designed to reduce the surface roughness but this cold metal forming process has further result like the surface hardening and further conclusions were also drawn:

- the novel magnetic assisted ball burnishing tool capable to reduce the surface of non-magnetizable materials, too,
- the magnetic assisted ball burnishing tool increases the surface hardness of C45

Keywords – magnetic assisted ball burnishing, technology optimization, material hardness, surface roughness.

I. INTRODUCTION

The MABB process is one of the cold-plastic finishing processes. It differs from other finishing solutions, such as hand scraping, lapping, grinding, etc., because it does not leave residual tension stresses on the machined surface. Furthermore, rolling is economically beneficial, because it is a simple and inexpensive process that requires short time and easy preparations. The introduced MABB process is unique, because the conventional burnishing is applied for finishing internal or external cylindrical surfaces, while the introduced MABB tool - thanks the special design - is suitable for flat or harmonically flat surfaces. The designed tool is shown in Fig. 1.

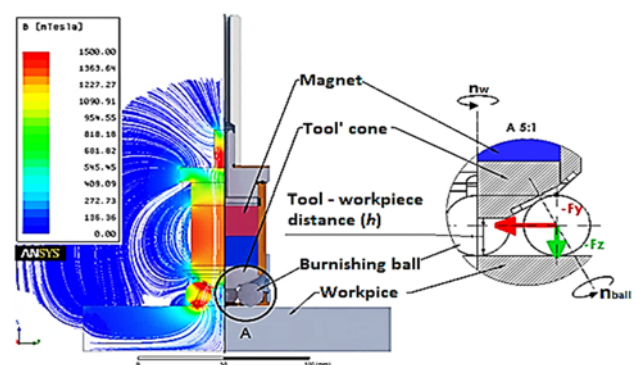

Fig. 1. Principle of MABB tool

The presented tool can be applied in conventional and CNC-controlled machines, too. During the analysis the tool is continuously cooled internally by Minimal Quantity Lubrication (MQL) oil. During this flat surface machining, while the tool moves on the planed path at the given feed rate, at the same time it rotates with a specific speed and as result it rolls down the surface.

In case of ferromagnetic materials, the required burnishing force is provided by the attractiveness of the

balls, if the tool approaches the workpiece at a given h distance [1] (Fig. 1). However, this magnetic force cannot be established on non-magnetizable materials, because the magnetic attraction between the balls and the cone does not allow the balls to rotate, so it results in the deterioration of the surface quality [2-3]. The reports also on such an experiment, using a magnetic chuck table to repel this phenomenon for the experiments.

II. RELATED RESULTS IN THE LITERATURE

There are many materials in our life, one of them are magnetizable and others are non-magnetizable, both types are important for the industry, however, in some cases the original state of the machined workpiece is it not suitable for the required usage. In such certain cases ball burnishing can change the material's roughness, hardness, corrosion and wearing resistance and decrease the incorporated stress values. In this paper, ball burnishing of flat C45 steel, KO36 austenite steel, AA7075 aluminium and PA6 polymer (Polyamide) are investigated.

A. C45 steel

The authors of this paper investigated in their former analysis the effects of ball burnishing on C45 steel applying the novel MABB tool [3]. But in this preliminary case the main aim was to determine the changes in ferrous materials' hardness and grain size. The C45 is a widely popular structured steel, so there are several studies in this topic, but cylindrical workpieces were examined in all of them. E.g. Alberto Saldana-Robles et al. have explored that the burnishing force and feed have the main effects on the process (on surface roughness) in case of C45 steel as presented in Fig. 2. [4].

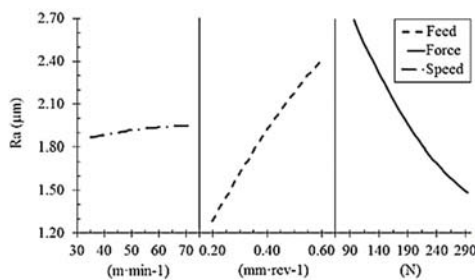

Fig. 2. Effect of technological parameters on roughness [4]

B. Stainless steels

Stainless steels are used in all areas of life, where parts exposed to hard environmental conditions and heavy loads, so it is important to have high strength and corrosion resistance. Lee et al. have studied the ball burnished AISI 316L stainless steel [5]. For the experiments, they used a 12 mm ball-ended tool after a milling process. They reported that the burnishing speed and the type of lubricant were found to affect the surface roughness most significantly, at a 99% level of confidence [5].

C. Aluminium

Aluminium and their alloys are widely used by the industry in large quantities because of low density and good mechanical properties. As other non-ferrous materials, the aluminium is also burnishable. Adel M. Hassan [6] and M.H. El-Axir et al. [7] explained the effects of ball burnishing of aluminium alloy. In both study AA2014 aluminium was applied, both of them burnished cylindrical workpiece, but Adel M. Hassan manufactured inner surface while M.H. El-Axir et al. machined the external surface. Their results are very similar, because they stated that the best results for average roughness is obtained when applying high depth of penetration. The reported also that the number of passes interacts with both burnishing speed and burnishing feed [6-8].

D. Plastics

Plastics and plastic-based raw materials play an increasingly important role in the industry. Lukasz Janczewski et al. (2016) have investigated the burnishing of PE500 polyethylene by diameter of 8 mm ball burnishing tool. Based on their results, the hardness of previously milled polyethylene after burnishing was increased only by 6%, while the wear was decreased by 58% [9]. Fig 3. reflects their results.

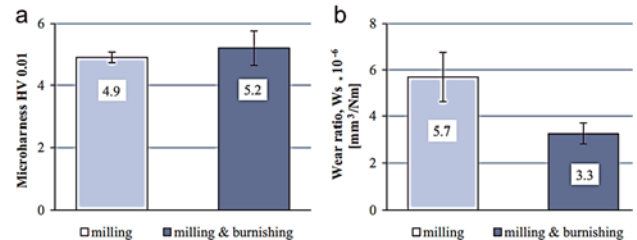

Fig. 3. a) Vickers hardness and b) wear rate for $F=150$ N and $f=0,04$ mm [9]

III. DESCRIPTION OF THE EXPERIMENTAL METHOD

The pre-machining process has also a very significant effect before any burnishing. It influences significantly the quality of the burnished's surface (e.g. accuracy and roughness), so analysing their effects is also a very important challenge. Different types of materials require different technological parameters for machining, in the given cases, the workpieces were pre-milled using technological parameters shown in Table 1-3.

Table 1. Technological parameters for C45.

o.	N	Feed- v_f [mm/min]	Cutting deep-a [mm]	Cutting speed- v_c [mm/min]
1		100	1	120
2		200	1	120
3		300	1	120

Table 2. Technological parameters for KO36.

o.	N	Feed- v_f [mm/min]	Cutting deep-a [mm]	Cutting speed- v_c [mm/min]
1		100	1	80
2		200	1	80
3		300	1	80

Table 3. Technological parameters for AA7075 and PA6.

o.	N	Feed- v_f [mm/min]	Cutting deep-a [mm]	Cutting speed- v_c [mm/min]
1		500	1	300
2		800	1	300
3		1100	1	300

For each workpiece, the feed rate was increased proportionally, indicating probably that the surface roughness values will also increase proportionally.

Because the KO36 austenite steel, AA7075 aluminium and PA6 polymer are non-magnetizable materials the necessary burnishing force cannot be generated. The solution was a magnetic table that was placed under the workpiece, as shown in Fig. 5.

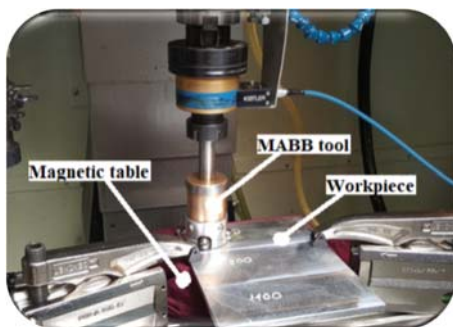

Fig. 5. Designation of experiments

Each specimen was cut to a dimension of 200×300×12 mm. For the addressed burnishing process experiments the standard Taguchi orthogonal array L9 (3^3) was designed which has three factors and three levels, the experimental results were analysed by MINITAB 17 software. The created Design of Experiments (DoE) table is shown in Table 4.

Table 4. DoE of ball burnishing.

o.	N	A	B	C
1	1	1	1	1
2	1	1	2	2
3	1	1	3	3
4	2	2	1	2
5	2	2	2	3
6	2	3	3	1
7	3	1	1	3
8	3	2	2	1
9	3	3	3	2

The factors in Table 4. are the same, expect the Ra roughness after milling, because there are four pre-milled different materials, see Table 5.

Table 5. Burnishing factors and levels for the Design of Experiments (DoE).

Factor	Level		
	1	2	3
Feed-(v_f) [mm/min]	0	3	5
Pre-milled roughness-(Ra) [μ m]	See in Table 6.		
Burnishing speed-(v_b) [m/min]	2	4	6
	0	0	0

For the analysis, $n=36$ experiments ($n=4 \cdot 9$) were carried out, because of the 9 experiments per material and there were 4 materials available. The pre-milling process produced different Ra roughness, so, it must be handled by the levels of the B factor according to the tested materials, as represented in Table 6.

Table 6. Ra roughness values after milling.

Material	B-1 [μ m]	B-2 [μ m]	B-3 [μ m]
C45	0,872	0,950	1,105
Ko36	1,455	2,553	1,249
AA7075	0,927	1,813	0,873
PA6	1,714	1,628	1,883

IV. RESULTS AND DISCUSSIONS

After the burnishing, the surfaces were evaluated by measuring the surface hardness, roughness and by microscopic pictures about the structure of the modified material layer. The following measuring equipment were used throughout the experimental work: for surface measurement MITUTOYO Formtracer SV-C3000, for hardness measurement Vickers microhardness tests have been performed with an optical microscope under a load of 100 g (Wilson-Wolpert 401 MVD microhardness HV_{0,1}

instrument), for microscopical evaluation a Zeiss Axio Imager.M2m light microscope and for SEM evaluation a Zeiss EVO MA10 SEM microscope was applied.

A. Surface roughness

After burnishing, the surface Ra roughness can be decreased even by 1/10 ratio compared to the original surface. This surface improvement is clearly visible in SEM images, see the milled surface in Fig. 6. and the burnished surface in Fig. 7.

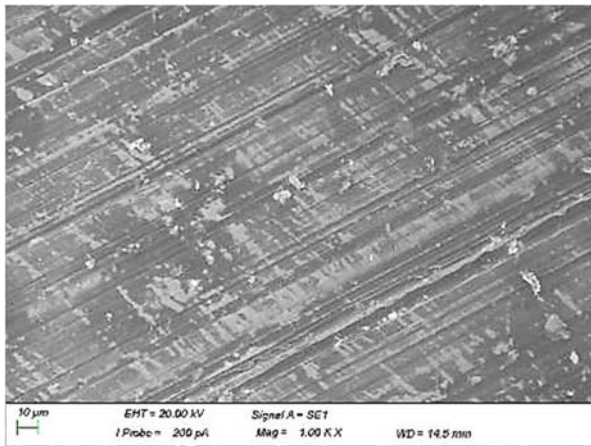

Fig. 6. SEM images of C45 surface after face milling, $Mag=1k\times$ ($v_f=200$ mm/min, $v_c=120$ m/min, $a_p=1$ mm, $Ra=1,105$ μm)

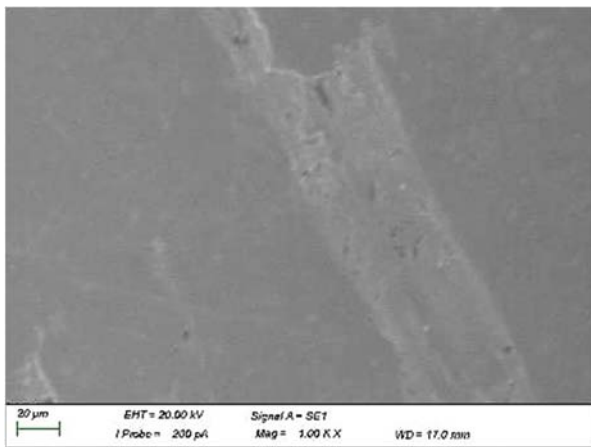

Fig. 7. SEM images of C45 surface after MABB burnishing, $Mag=1k\times$ ($v_f=200$ mm/min, $v_b=120$ m/min, pre-Ra=1,105 μm , burnished Ra=0,127 μm)

Figs. 8–11. show three-dimensional fitted curves by distance based interpolation method, as representation examples of the effects of various combinations of the selected ball burnishing parameters (burnishing speed, feed, pre-milled surface roughness) on the final Ra roughness of the C45, KO36, AA7075 and PA6 workpieces after burnishing by the novel MABB tool. It is worth mentioning that each curve represents the effects of two input parameters while the third (feed (v_f)) was kept at constant level where the resulted roughness was the

smallest.: in case of C45 and PA6 polymer the $v_f=10$ mm/min while in case of AA7075 and KO36 the $v_f=20$ mm/min produced the lowest surface roughness.

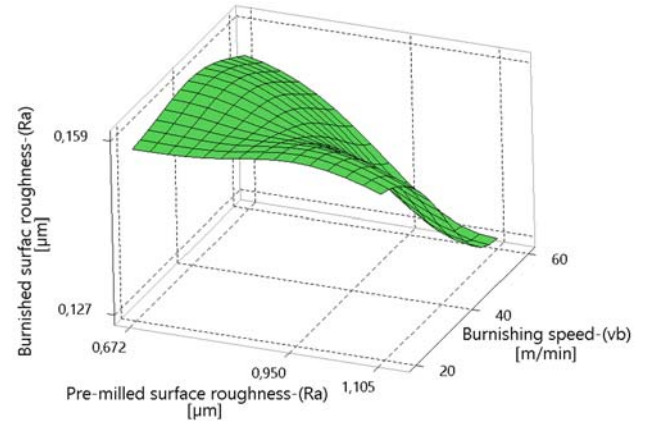

Fig. 8. Effect of burnishing speed and pre-milled surface roughness on surface average roughness of C45, $v_f=10$ mm/min

A surprising result is shown in Fig 8. (material: C45), where the highest burnishing speed ($v_b=60$ m/min) and pre-milled roughness ($Ra=1,105$ μm) provided the lowest final surface roughness ($Ra=0,127$ μm) after burnishing. The suspicion is that the high pre-milling roughness provides relative high amount of material for plastic deformation. Furthermore, the high burnishing speed guarantees the high number of passes on the same material sub-surface.

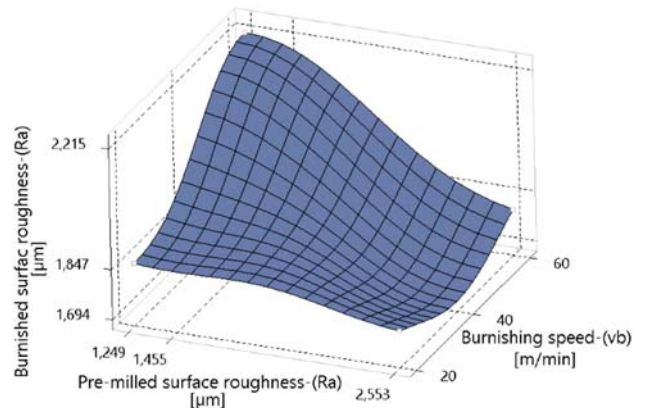

Fig. 9. Effect of burnishing speed and pre-milled surface roughness on surface average roughness of KO36, $v_f=20$ mm/min

On the basis of the curve presented in Fig. 7. (KO36 austenite steel), it can be seen that the reduction in surface roughness is caused mainly by the pre-milled surface roughness, indicating that the burnishing speed has less effect.

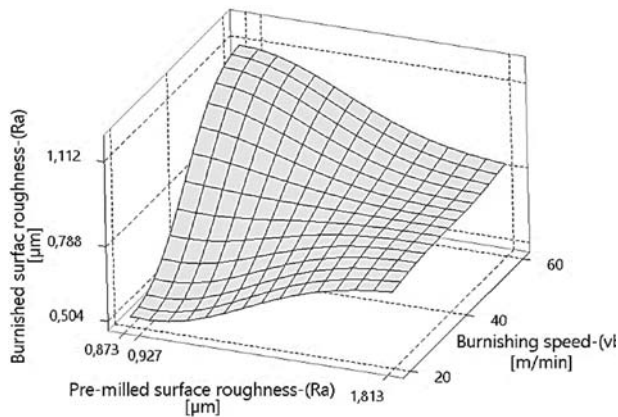

Fig. 10. Effect of burnishing speed and pre-milled surface roughness on surface average roughness of AA7075, $v_f=20$ mm/min

According to Fig. 10. (AA7075 aluminium) it can be concluded that the initial low pre-milled surface produces low surface average roughness. The increase of the burnishing speed increases the surface average roughness, too. The plasticity of AA7075 should be the main reason of this phenomenon.

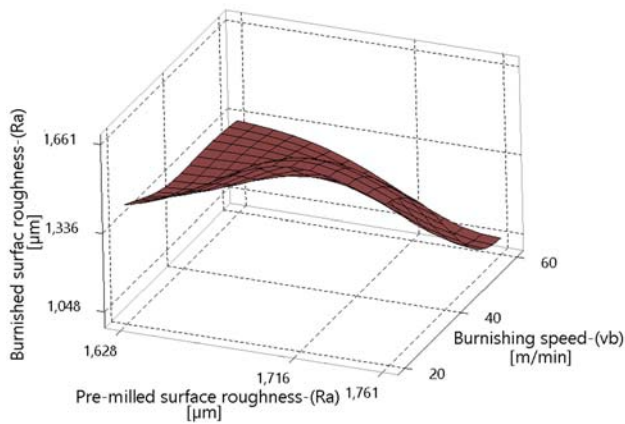

Fig. 11. Effect of burnishing speed and pre-milled surface roughness on surface average roughness of PA6 polymer; $v_f=10$ mm/min

In Fig. 11. (PA6 polymer) the effects of the machining parameters are similar to the case of C45, so, the best results were obtained at the highest speed and pre-milling surface roughness.

B. Surface hardness

Figs. 12. and 14. show the resulted burnished surface hardness depending on the depth in the material and Figs. 13. and 15. show the microstructure images of C45 after burnishing with the novel MABB tool. The C45 surface material has reached the highest roughness reductions (from $R_a=1,105 \mu\text{m}$ to $R_a=0,127 \mu\text{m}$), consequently, the highest material compaction was realized in this case. At all of the 9 tests the surface hardness of C45 steel get

increased up to $220 \text{HV}_{0,1}$ from $185 \text{HV}_{0,1}$ (base material hardness without machining), see in Fig. 12.

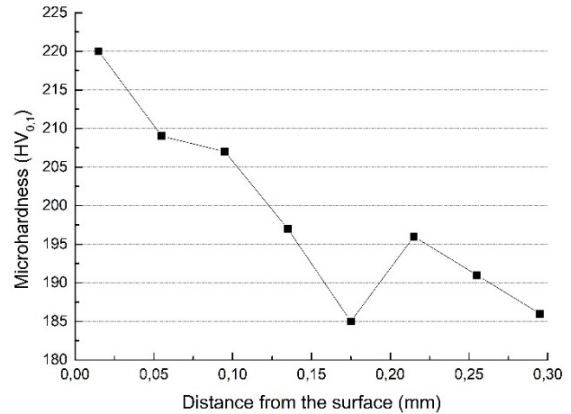

Fig. 12. Surface hardness of C45, No. 5 experiment

As Fig. 12. shows there is a valley in the curve between 0,15 and 0,25 mm depth from the surface, after it the material hardness reaches the base material hardness. This phenomena can be discernible at all of the hardness measurements. The rough grain layer which was generated between the upper fine grain layer by burnishing and the grain of the base material (Fig. 13. and 15.) could be the reason for that phenomena.

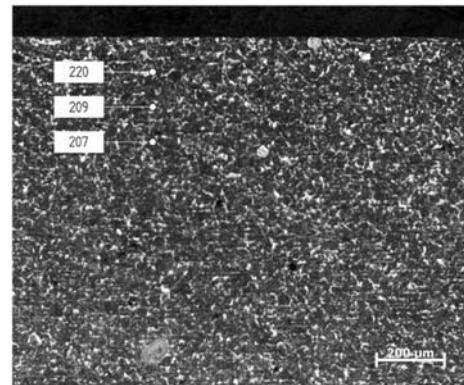

Fig. 13. Microstructure image of C45 surface and the hardness dispersion, No. 5 experiment

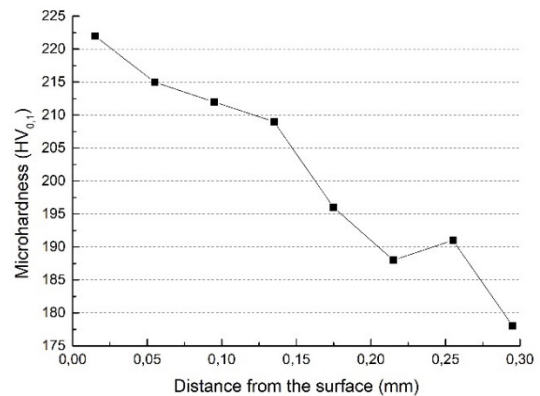

Fig. 14. Surface hardness of C45, No. 6 experiment

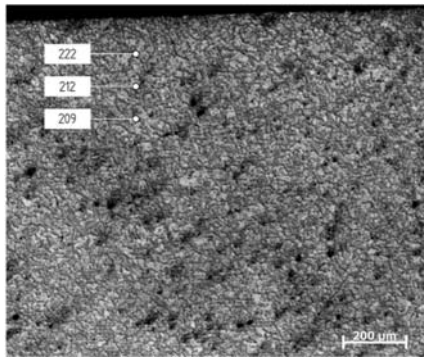

Fig. 15. Microstructure image of C45 surface and the hardness dispersion, No. 6 experiment

As the Fig. 12 and 14. shows the thickness of the hardening layer is about 0,1 mm. This value is more than the author's original expectation, similarly to the values of the hardness. In case of KO36 and PA6 after the burnishing the compaction of these materials were negligibly small, so it is not possible the evaluation them, because of the hardened layer thickness in comparison to the range of $HV_{0,1}$ microhardness measuring instrument. The measured Ra roughness of AA7075 mirrors that the decrease in it was similar to the decrease at C45, as shown in Fig. 16.

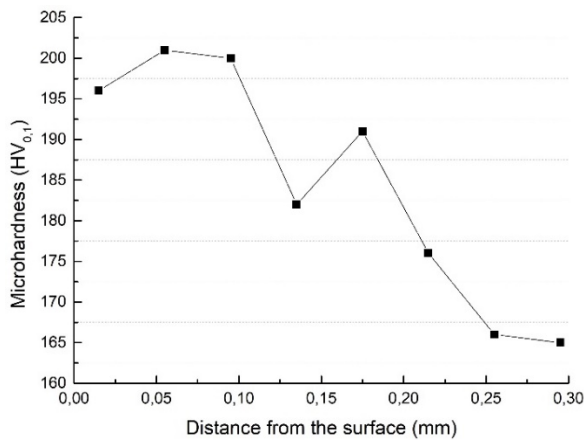

Fig. 16. Surface hardness of AA7075, No. 2 experiment

The surface hardness of AA7075 get increased up to 200 $HV_{0,1}$ from 165 $HV_{0,1}$ (base material hardness without machining).

V. CONCLUSIONS AND OUTLOOK

Analyses results on the ball burnishing technological parameters, on totally different behaving materials (steels, aluminium, PA6 polymer) and on the effects of the pre-milling surface roughness are reported in the given paper applying the novel Magnetic Assisted Ball Burnishing (MABB) tool for machining flat surfaces in which the balls rotate to generate high-speed and long-distance sliding under a constant burnishing force, generated by magnetic flux.

The conclusions of this work can be summarized as follows:

- The proposed MABB tool can burnish also non-magnetizable metals and other materials, supporting by a magnetic table.
- The best results for average roughness is obtained at low feed rate.
- At AA7075 aluminium low average surface roughness can be reached with low technological parameters.
- The machining of KO36 austenite steel similarly to AA7075 aluminium requires low technological parameters.
- Burnishing of PA6 polymer has acceptable roughness reductions, but the process is very sensitive to the technological parameters.
- The hardness of the C45 steel after the proposed MABB machining can be upgraded by 20 percent.
- The hardness of the AA7075 aluminium also can be upgraded by 20 percent.
- The hardened layer thickness reached about 0,1 mm in case of C45 and A7075 machinings.
- The fine grain structure of the C45 material was measured after burnishing.

The results implicate further research and experiments. The PA6 polymer hardness measurement can be preformed, because the hardness measuring instrument is not suitable for polymer, but there exists specials hardness measurement instruments designed for polymers. In case of KO36 austenite steel it is well known that the austenite microstructure is transformed into martensite by mechanical loads, it can be analysed, too. Another, short term plan is the measuring of the surface profile macrogeometrical change after burnishing, since currently, the effects of burnishing on the roughness are already known, but the effects for the surface topological accuracy are not yet explored.

VI. ACKNOWLEDGMENTS

This research is partly supported by EFOP-3.6.1-16-2016-00006 "The development and enhancement of the research potential at John von Neumann University" project. The Project is supported by the Hungarian Government and co-financed by the European Social Fund.

The research in this paper was (partially) supported by the European Commission through the H2020 project EPIC (<https://www.centre-epic.eu/>) under grant No. 739592 and by the Hungarian ED_18-2-2018-0006 grant on an "Research on prime exploitation of the potential provided by the industrial digitalisation".

VII. REFERENCES

- [1] Kovácsa, Zs.F.; Viharos, Zs.J.; Kodácsy, J.: Determination of the working gap and optimal machining

- parameters for magnetic assisted ball burnishing, *Measurement 118*, 2018, pp. 172-180.
- [2] **Kovácsa, Zs.F.; Viharos, Zs.J.; Kodácsy, J.:** Determination of the optimal working gap for the magnetic assisted ball burnishing tool, *International Measurement Confederation (IMEKO)*, 2017, pp. 170-175.
- [3] **Kovácsa, Zs.F.; Viharos, Zs.J.; Kodácsy, J.:** Making twist-free surfaces by magnetic assisted ball burnishing, *Solid State Phenomena 261*, 2017, pp. 159-166.
- [4] **Saldaña-Roblesa A.; Plascencia-Morab H.; Aguilera-Gómez E.; Saldaña-Roblesa A.; Marquez-Herrera A.; Diosdado-De la Peña J.A.:** Influence of ball-burnishing on roughness, hardness and corrosion resistance of AISI 1045 steel, *Surface and Coatings Technology*, Vol. 339, 2018, pp. 191-198.
- [5] **Lee, S.S.G.; Tam S.C.; Loh, N.H.:** Ball burnishing of 316L stainless steel, *Journal of Materials Processing Technology* 37, 1993, pp. 241-251.
- [6] **HASSAN A.M.:** The effects of ball- and roller-burnishing on the surface roughness and hardness of some non-ferrous metals, *Journal of Materials Processing Technology* 72, 1997, pp. 385-391.
- [7] **El-Axir, M.H.; Othmanb, O.M.; Abodiena A.M.:** Study on the inner surface finishing of aluminum alloy 2014 by ball burnishing process, *Journal of Materials Processing Technology* 202, 2008, pp. 435-442.
- [8] **Kovácsa, Zs.F.; Viharos, Zs.J.; Kodácsy, J.:** The effects of machining strategies of magnetic assisted roller burnishing on the resulted surface structure, *Materials Science and Engineering* 448, 2018, pp. 1-8.
- [9] **Janczewski, Ł.; Toboła, D.; Brostow, W.; Czechowski, K.; Lobland, H.E.H.; Kot, M.; Zagórski, K.:** Effects of ball burnishing on surface properties of low density polyethylene, *Tribology International* 93, 2019, pp. 36-42.